



PROTEUS™ BEAM



FEATURES

- Innovative IP65 Rated Moving Head Beam Luminaire**
- Philips™ MSD Platinum 14R 280W 80CRI, 7,800K Lamp**
- Precise 2.5° Beam Aperture and Advanced Optics**
- Revolutionary Internal Thermal Cooling System**
- Full CMY Color Mixing**
- 13 Dichroic Colors including CTB, CTO, and UV**
- 8 Rotating Interchangeable and 13 Static-Stamped Gobos**
- 5 and 32 Facet Rotating Prisms and Frost Filter**
- Motorized Focus and Auto-Focus**
- High Speed Mechanical Shutter and Strobe**
- DMX, RDM, Art-NET, and sACN Support**
- Elation's E-FLY™ Internal Wireless DMX Transceiver**



The PROTEUS BEAM™ an innovative full featured IP65 rated moving head beam luminaire with the Philips™ MSD Platinum 14R 280W 80CRI 7,800K lamp producing over 12,000 total lumens. Features include an advanced optical system producing a precise 2.5° beam aperture, a revolutionary internal thermal cooling system, full CMY color mixing, 13 dichroic colors including CTB, CTO, and UV, 8 rotating interchangeable and 13 static-stamped metal gobos, 5 and 32 facet rotating prisms, frost filter, motorized focus and auto-focus, high speed mechanical shutter and strobe, DMX, RDM, Art-NET, and sACN protocol support, Elation's E-FLY™ internal wireless DMX transceiver, IP rated 5pin XLR and RJ45 etherCON in/out connections, powerCON TRUE1 in, full color 180° reversible menu display with 6 button touch control panel, battery backup for display power, 500W max power consumption, and a multi-voltage universal auto switching power supply (100-240v).



Specifications subject to change without notice ©Elation Professional 11/07/17

Elation Professional USA | 6122 S. Eastern Ave. | Los Angeles, CA. 90040
323-582-3322 | 323-832-9142 fax | www.elationlighting.com | info@elationlighting.com

Elation Professional B.V. | Junostraat 2 | 6468 EW Kerkrade, The Netherlands
+31 45 546 85 66 | +31 45 546 85 96 fax | www.elationlighting.eu | info@elationlighting.eu

PRODUCT SPECIFICATIONS

SOURCE

Philips MSD Platinum 14R 280W 80CRI 7,800K Lamp
1,500 Hour Average Lamp Life*

*May vary depending on several factors including but not limited to:
Environmental Conditions, Power/Voltage, Usage Patterns (On-Off Cycling), Control and Dimming.

PHOTOMETRIC DATA

80CRI | > 12,000 Lumens
136,800 LUX 12,709 FC @49.2' (15m) (2.5° Full ON)

EFFECTS

5 and 32 Facet Rotating Prisms and Prism Macros
Frost Filter Hybrid Wash Effect
Motorized Focus and Auto-Focus
High Speed Mechanical Shutter and Strobe

COLOR

13 Dichroic Colors including CTB, CTO, and UV
Full CMY Color Mixing

GOBOS

(8) Interchangeable Rotating / Indexing Glass Gobos
(13) Static-Stamped Metal Gobos

CONTROL / CONNECTIONS

(3) DMX Channel Modes (28 total channels)
6 Button Touch Control Panel
Full Color 180° Reversible LCD Menu Display
8 / 16 Bit Resolution Adjustable Movement
DMX, RDM, Art-NET and sACN Protocol Support
Elation E-FLY™ Internal Wireless DMX Transceiver
IP65 5pin DMX In/Out
IP65 RJ45 Ethernet In/Out
IP65 powerCON TRUE1 Power In

SIZE / WEIGHT

Length: 17.1" (445mm)
Width: 17.87" (454mm)
Vertical Height: 26.77" (680mm)
Weight: 77.0 lbs. (35.0 kg)

ELECTRICAL / THERMAL

AC 100-240V - 50/60Hz
500W Max Power Consumption
14°F to 113°F (-10°C to 45°C)

APPROVALS / RATINGS



ORDERING INFORMATION

PRB014	PROTEUS BEAM™
DRCPROTB	Dual Touring Road Case For PROTEUS BEAM™
TRIGGER CLAMP	Heavy Duty Wrap Around Hook Style Clamp
EFL001	E-FLY™ Wireless DMX Transceiver
SCABLE60	24" (610mm) 60 lbs. (27 kg) Rated Safety Cable

PHOTOMETRIC DATA

2.5° Beam Aperture

	15 m	49.2 ft	20 m	65.6 ft	25 m	82.0 ft
Diameter	0.66	2.2	0.88	2.9	1.1	3.6
	lux	fc	lux	fc	lux	fc
FULL ON	136,800	12,709	81,050	7,530	49,170	4,568

COLORS AND GOBOS



INTERCHANGEABLE-ROTATING GOBO WHEEL 1

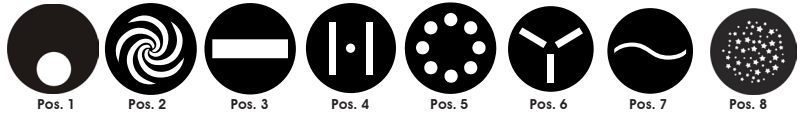

STATIC-FIXED GOBO WHEEL 2



****IMPORTANT NOTICE REGARDING GOBO DIMENSIONS AND CUSTOM GOBOS****
Due to the extreme high temp optical system, special material and design requirements are required.
Please contact ELATION Customer Support for specific details.

DIMENSIONAL DIAGRAMS

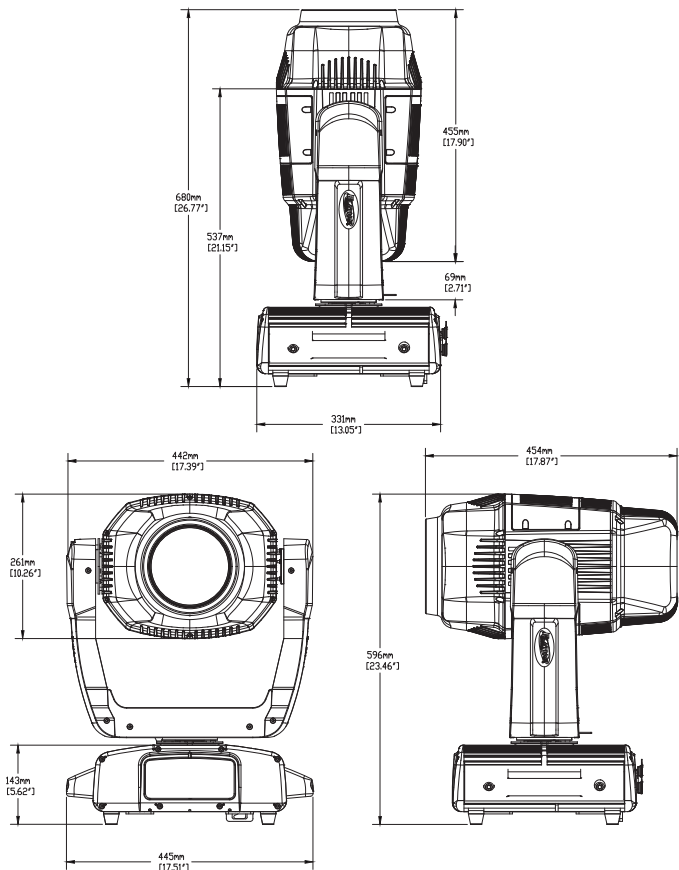

Specifications subject to change without notice ©Elation Professional 11/07/17

